

FS-MDDR1 Insert compatible with Middara®: Unintentional Malum Act 1



Assembly Instructions

The package contains 12 sheets: four double and four single sheets.
 The part marked in sheet A2 is to be discarded.
 After assembly the trays are put in three layers in the original game box.
 Ordinary PVA glue is required when assembling each tray.
 Please make sure you dry-assemble each tray correctly before gluing it together.
 Please check www.foldedspace.net for general assembly tips.

FS-MDDR1

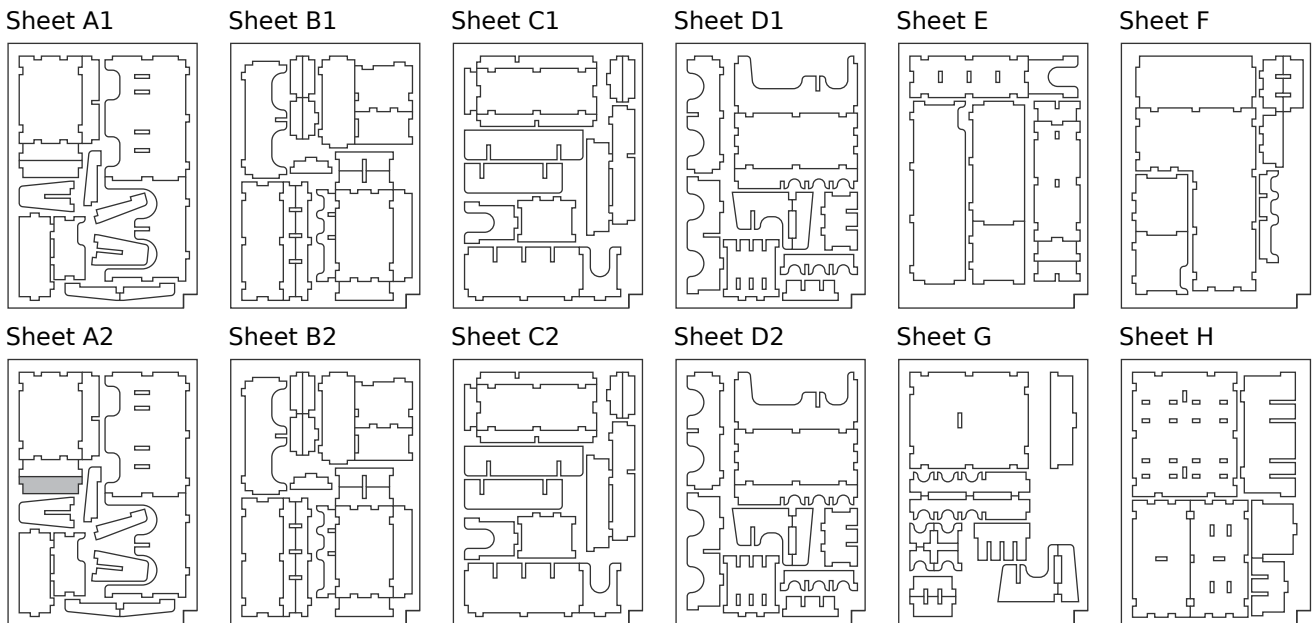
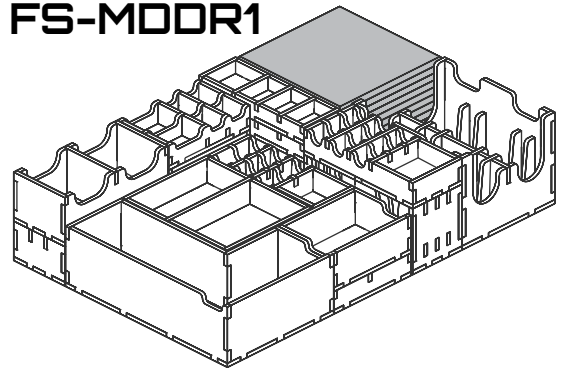

Tray 1

Sheet B1, B2

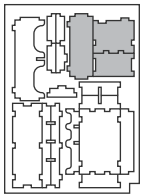

Step 1

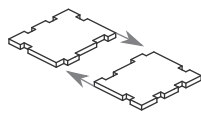

Step 2

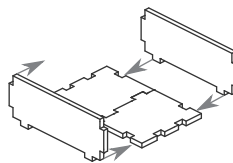

Step 3

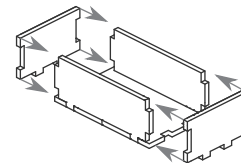

Finished tray

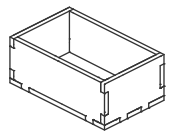

Tray 2

Sheet C1, C2 Sheet G

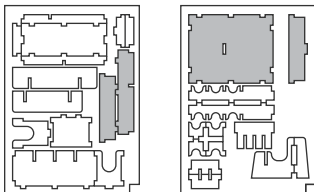

Step 1

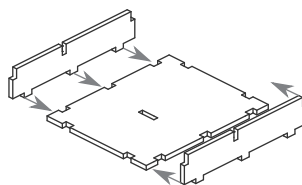

Step 2

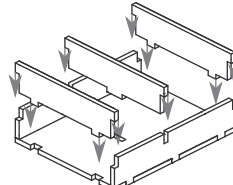

Finished tray

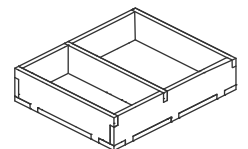

Tray 3

Sheet B1, B2 Sheet C1, C2 Sheet H

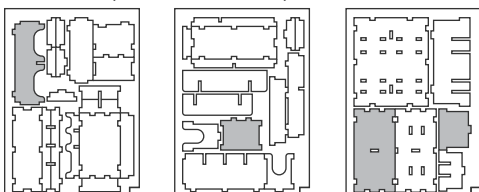

Step 1

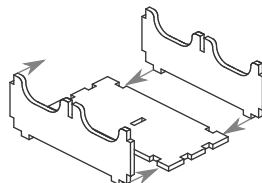

Step 2

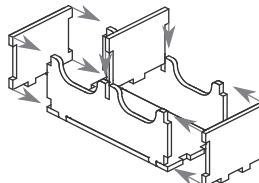

Finished tray

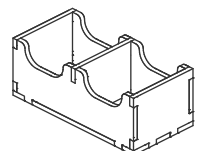

FS-MDDR1 Insert compatible with Middara®: Unintentional Malum Act 1

Tray 4

Sheet D1, D2 Sheet H

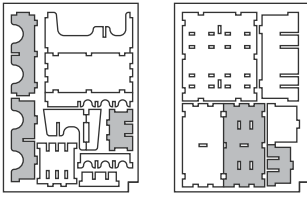

Step 1

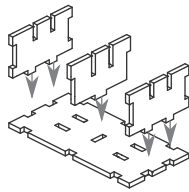

Step 2

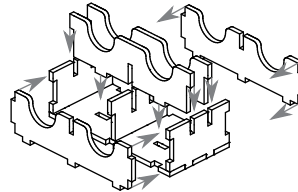

Finished tray

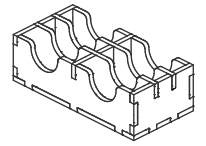

Tray 5

Sheet E Sheet F

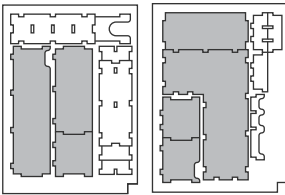

Step 1

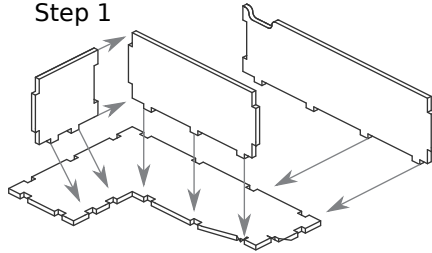

Step 2

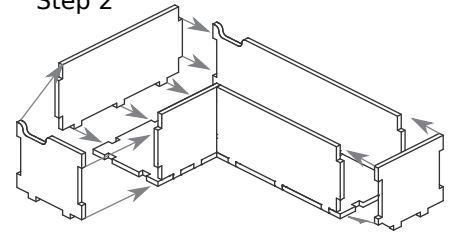

Finished tray

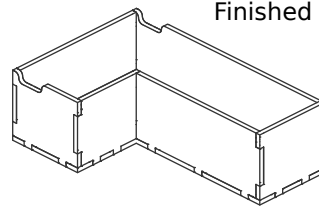

Tray 6

Sheet C1, C2 Sheet E

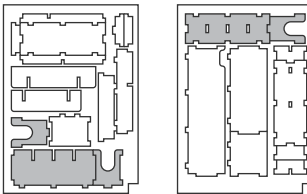

Step 1

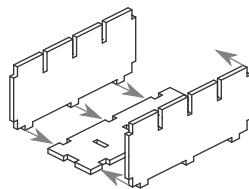

Step 2

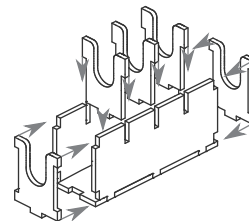

Finished tray

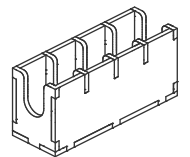

Tray 7a, 7b

Sheet A1, A2

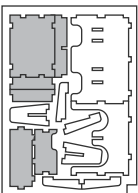

Step 1

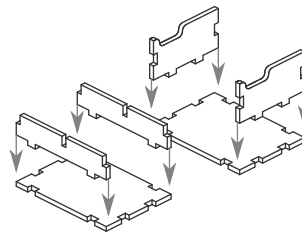

Step 2

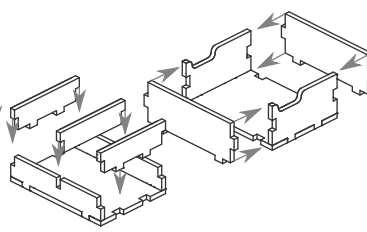

Finished tray

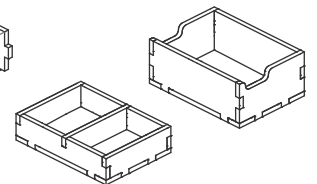

Tray 8a, 8b

Sheet B1, B2 Sheet F

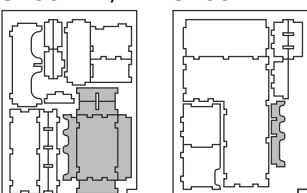

Step 1

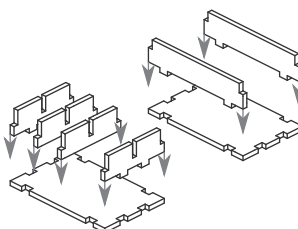

Step 2

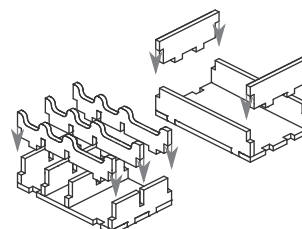

Finished tray

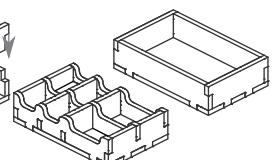

FS-MDDR1 Insert compatible with Middara®: Unintentional Malum Act 1

Tray 9a, 9b

Sheet C1, C2

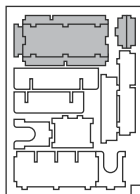

Step 1

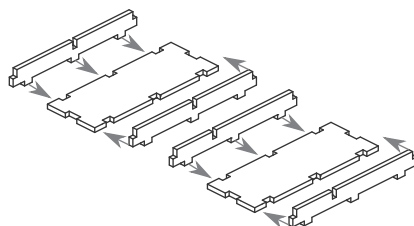

Step 2

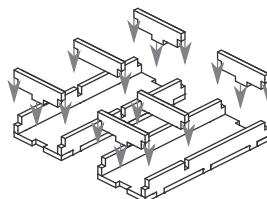

Finished tray

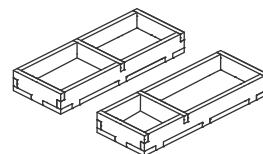

Tray 10a, 10b (the trays are identical)

Sheet B1, B2

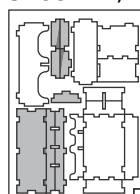

Step 1

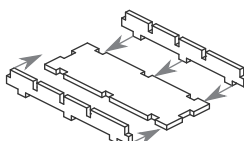

Step 2

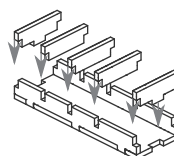

Finished tray

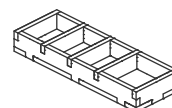

Tray 11

Sheet E

Sheet G

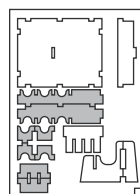
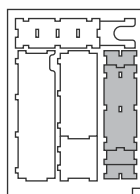

Step 1

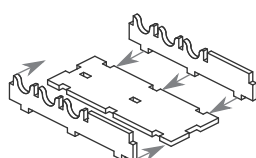

Step 2

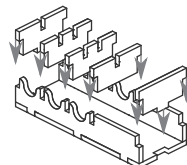

Step 3

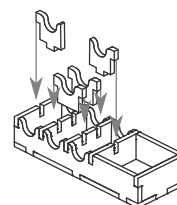

Finished tray

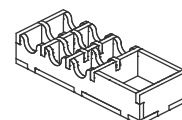

Tray 12

Sheet A1, A2

Sheet H

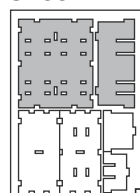
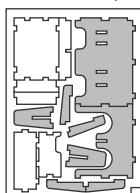

Step 1

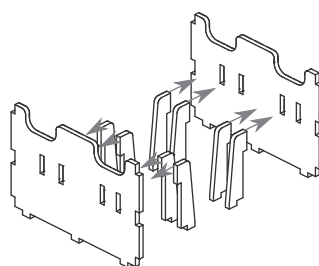

Step 2

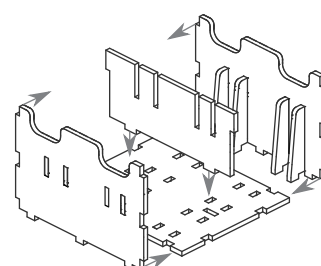

Step 3

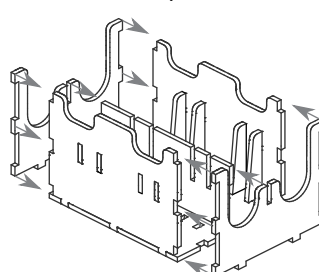

Step 4

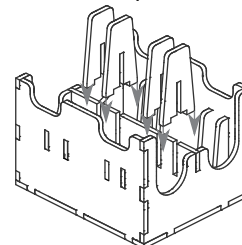

Finished tray

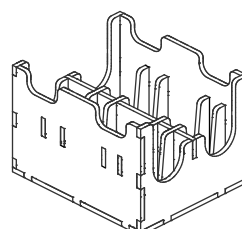

FS-MDDR1 Insert compatible with Middara®: Unintentional Malum Act 1

Tray 13a, 13b

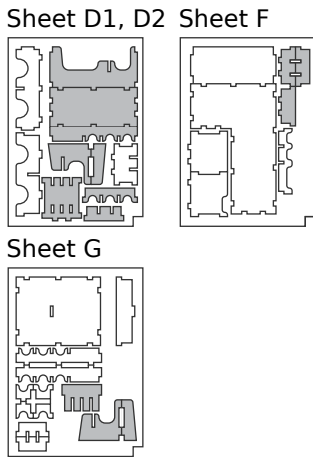

Step 1

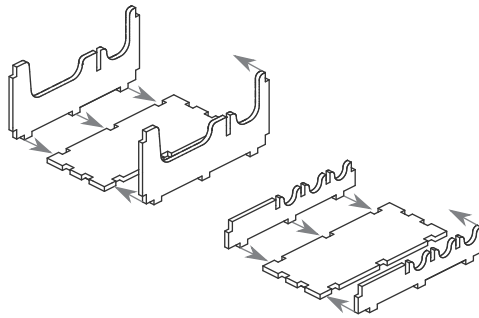

Step 2

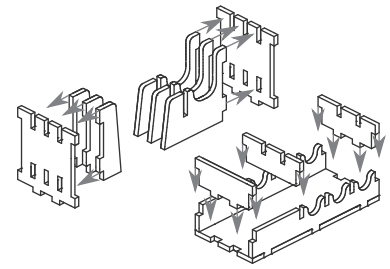

Step 3

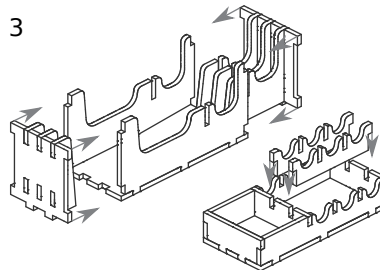

Step 4

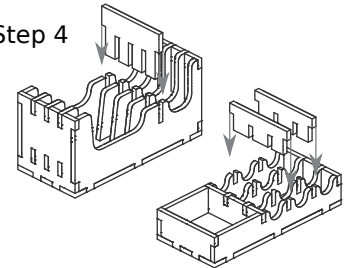

Finished tray

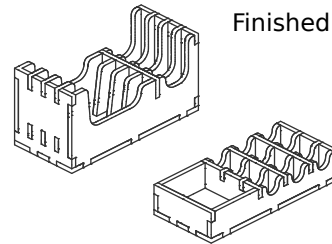

Tray 14

Sheet C1, C2

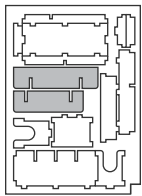

Step 1

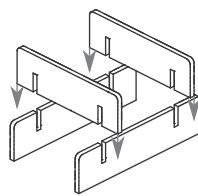

Finished tray

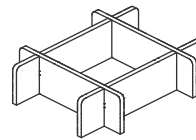

Please check www.foldedspace.net for photos of this insert in use.

FS-MDDR1

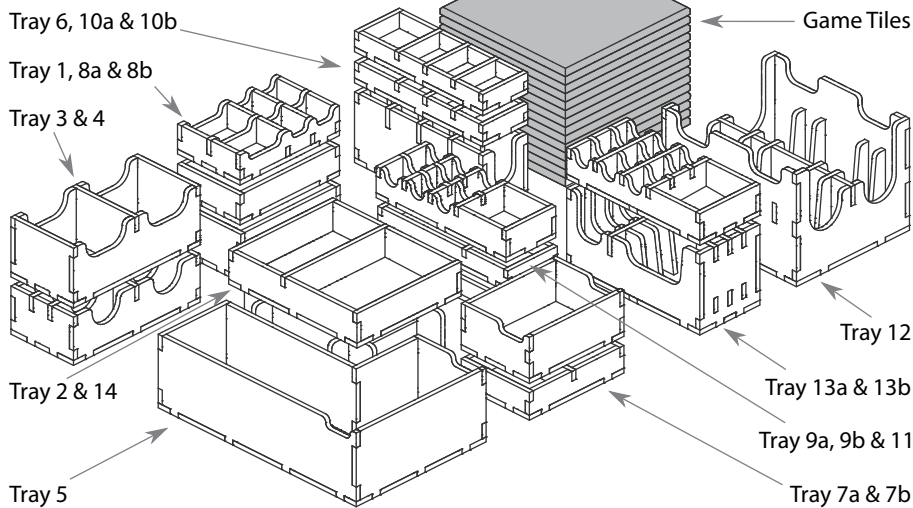

Tray legend:

- Tray 1 - medium combatant minis
- Tray 2 - large and male standups, plus plastic bases
- Tray 3 - small combatant minis
- Tray 4 - discipline & initiative cards
- Tray 5 - large combatant minis
- Tray 6 - item upgrade, combatant loot & small hidden card decks
- Tray 7a, b - character minis, and female standups & card bases
- Tray 8a, b - base discs and terrain tokens
- Tray 9a, b - dice & other tokens, and enslaved spirit & spirit blade standups
- Tray 10a, b - damage & tracker tokens and SP, urgency & other tokens
- Tray 11 - ability tokens
- Tray 12 - standard sized card decks
- Tray 13a, b - effect tokens and player card tray
- Tray 14 - filler tray, to be replaced with sleeved adventurer and combatant cards as needed