

FS-7WDUELv2

compatible with 7 Wonders Duel®,
including the Agora® and Pantheon® expansions

Assembly Instructions

The package contains 2 sheets, both of them are identical.

After assembly the trays are put in two layers in the original game box.

Ordinary PVA glue is required when assembling each tray.

Please make sure you dry-assemble each tray correctly before gluing it together.

Please check www.foldedspace.net for general assembly tips.

FS-7WDUELv2

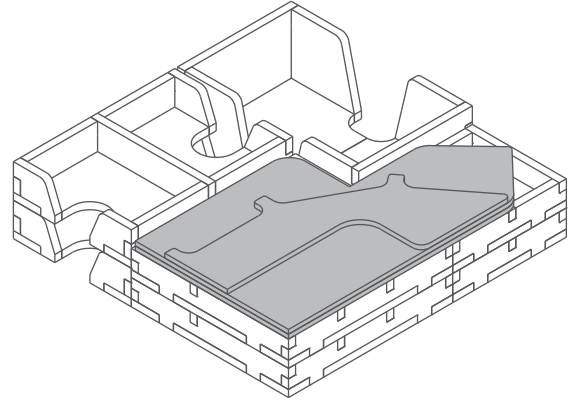

Sheet A1

Sheet A2

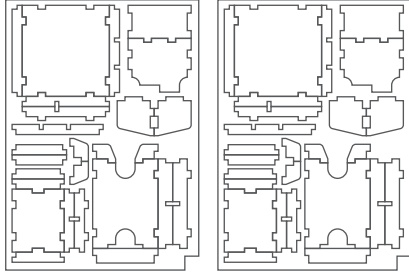

Tray 1a & 1b (the trays are identical)

Sheet A1

Sheet A2

Step 1

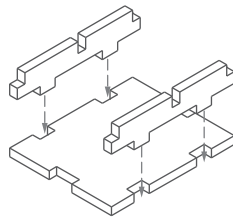
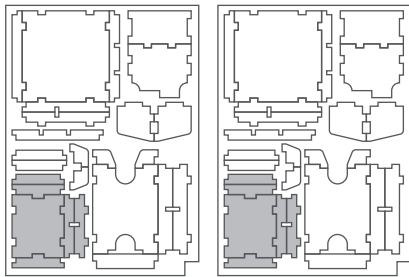

Step 2

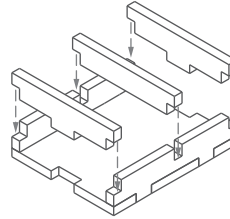

Finished tray

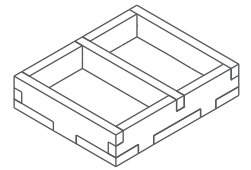

Tray 2a & 2b (the trays are identical)

Sheet A1

Sheet A2

Step 1

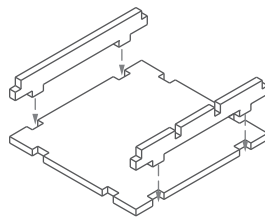
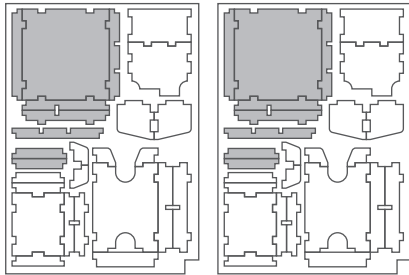

Step 2

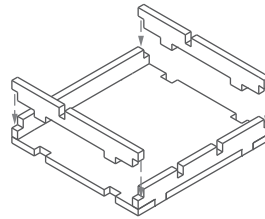

Step 3

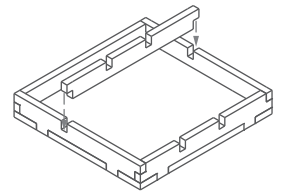

Step 4

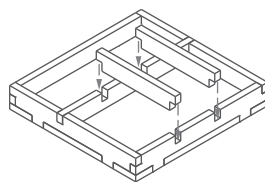

Finished tray

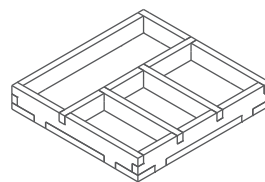

Tray 3a & 3b

(the trays are identical)

Sheet A1

Sheet A2

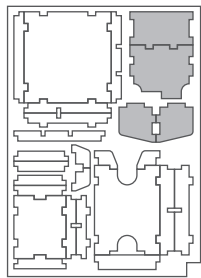
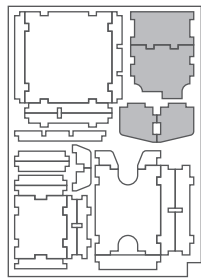

Step 1

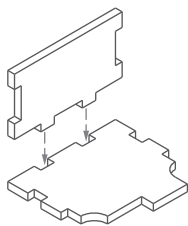

Step 2

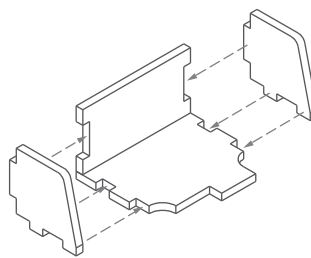

Finished tray

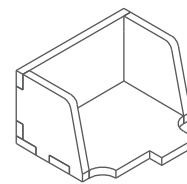

Tray 4a & 4b

(the trays are identical)

Sheet A1

Sheet A2

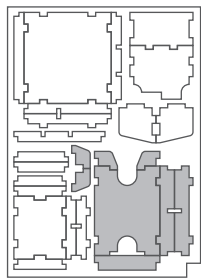
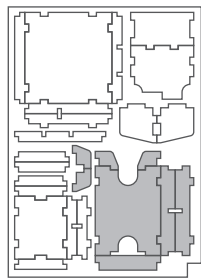

Step 1

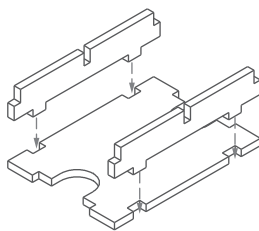

Step 2

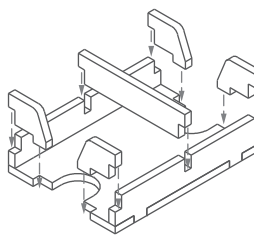

Finished tray

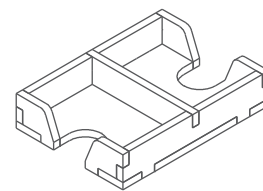

FS-7WDUELv2

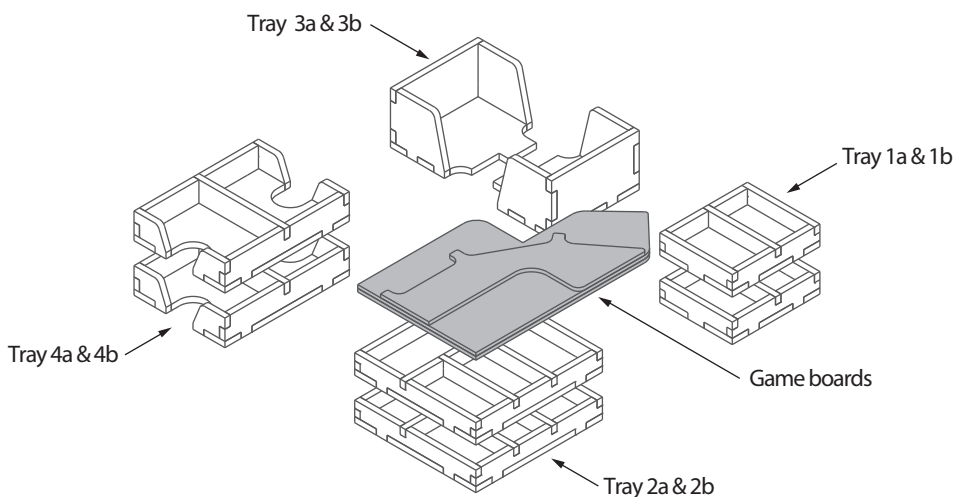

Please check www.foldedspace.net for photos of this insert in use.

Tray legend:

- Tray 1a - red pawns and other tokens
- Tray 1b - military tokens
- Tray 2a - progress tokens, influence cubes, and mythology tokens
- Tray 2b - decree tokens and coins
- Tray 3a, b - large cards and score pad
- Tray 4a - age I and age II card decks
- Tray 4b - age III and guild, grand temple & senator cards

Note: the two red pawns need to be placed on the right hand side of Tray 1a so that their bases fit around the pointed end of the main board. Note also that if all cards are sleeved there is space for just a single score pad in Trays 3a & b.