

FS-TTA insert compatible with Through the Ages: A New Story of Civilization, incl. the New Leaders and Wonders® expansion

Assembly Instructions

The package contains 5 sheets, two identical to the other two and one different sheet.

The part marked in sheet A2 is to be discarded.

After assembly the trays are put in three layers in the original game box.

Ordinary PVA glue is required when assembling each tray.

Please make sure you dry-assemble each tray correctly before gluing it together.

Please check www.foldedspace.net for general assembly tips.

FS-TTA

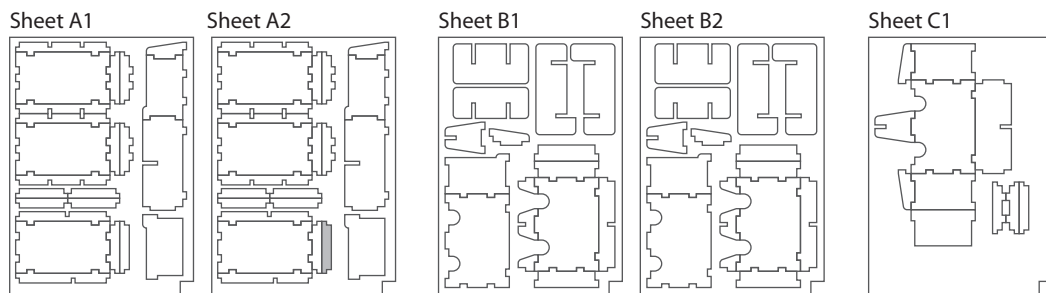
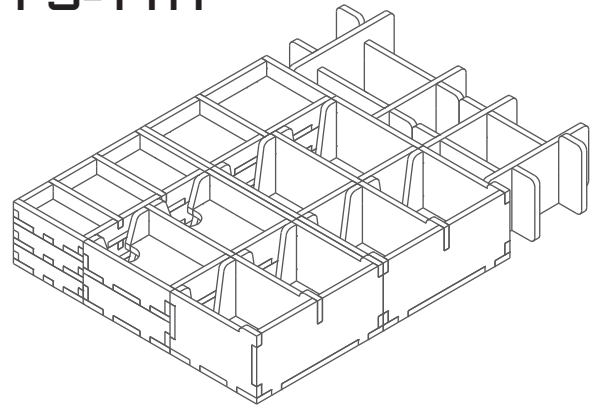

Tray 1a

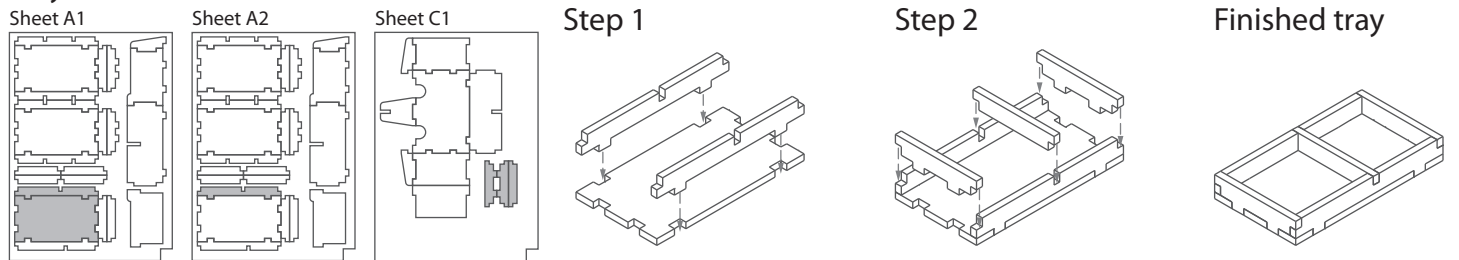

Tray 1b

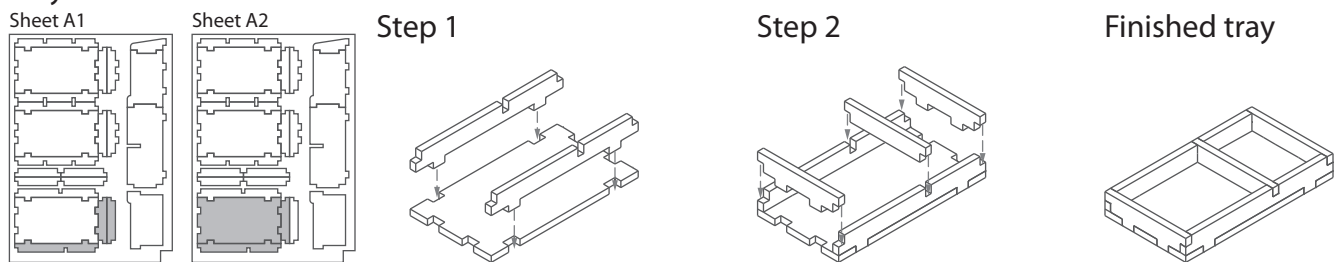

Tray 2a, 2b, 2c & 2d (the trays are identical)

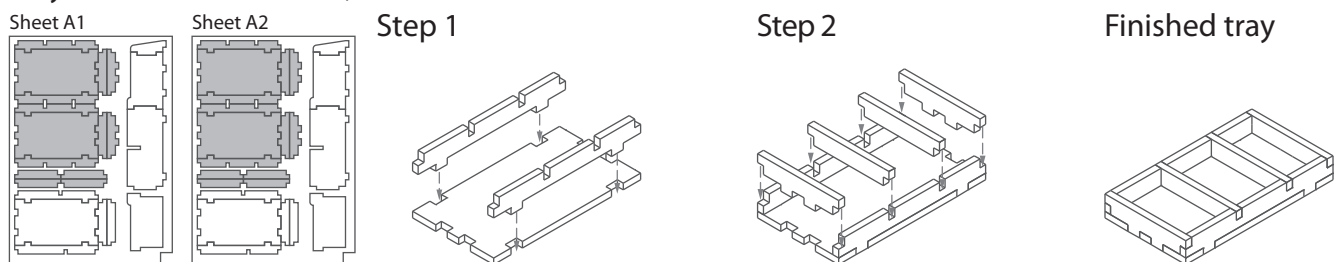

Tray 3a & 3b (the trays are identical)
Sheet A1, A2 Sheet B1, B2

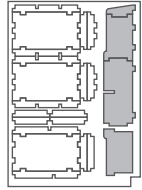

Step 1

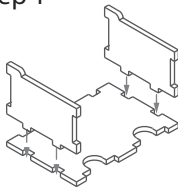

Step 2

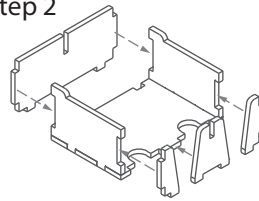

Step 3

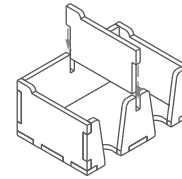

Finished tray

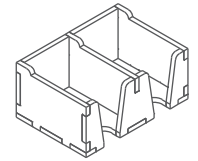

Tray 4

Sheet C1

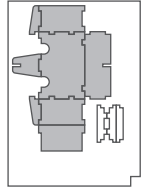

Step 1

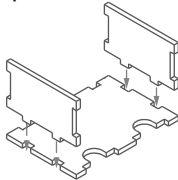

Step 2

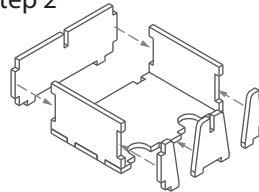

Step 3

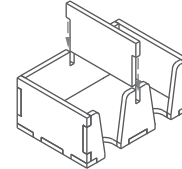

Finished tray

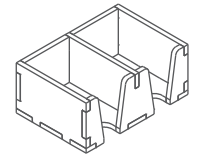

Tray 5a & 5b (the trays are identical)

Sheet B1

(the trays are identical)

Sheet B2

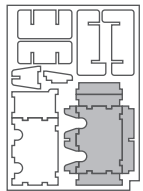
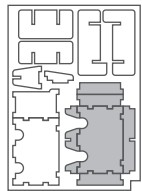

Step 1

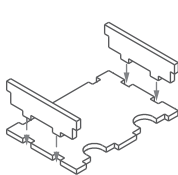

Step 2

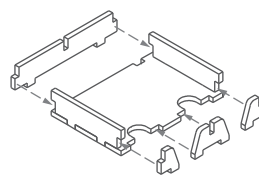

Step 3

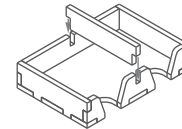

Finished tray

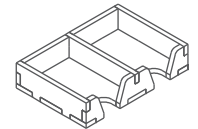

Tray 6a

Sheet B1

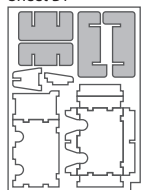

Step 1

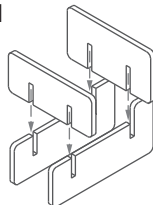

Finished tray



Tray 6b (mirrored version of Tray 6a)

Sheet B2

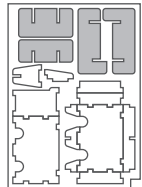

Repeat approach of Tray 6a, but swap bottom pieces over

Finished tray



Note: taller ended piece is on the other side from Tray 6a

FS-TTA

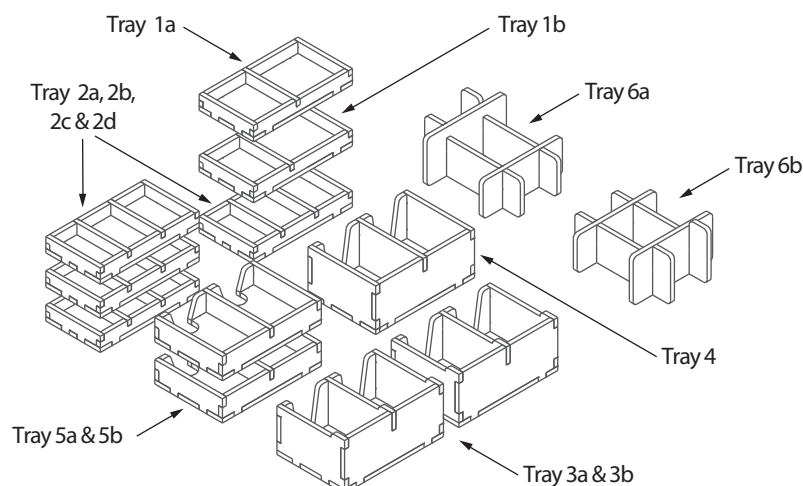

Please check www.foldedspace.net for photos of this insert in use.

Tray legend:

- Tray 1a - red and white cubes
- Tray 1b - spare yellow and blue cubes
- Tray 2a, b, c, d - player pieces and starting blue and yellow cubes
- Tray 3a - age II civil and military decks
- Tray 3b - age III civil and military decks
- Tray 4 - age I civil and military decks
- Tray 5a - age A civil and military decks
- Tray 5b - other cards and starting player tile
- Tray 6a, b - filler trays for holding small game boards

Note: the game has a lot of boards. Please check our product page on our website to see how best to layer them on top of the insert trays to neatly fill the box.