

FS-ARLE insert compatible with Fields of Arle®, including the Tea & Trade® expansion



Assembly Instructions

FS-ARLE

The package contains 5 sheets, two identical to the other two and one different sheet.

After assembly the trays are put in three layers in the original game box.

Ordinary PVA glue is required when assembling each tray.

Please make sure you dry-assemble each tray correctly before gluing it together.

Please check www.foldedspace.net for general assembly tips.

The game and expansion contain a lot of boards and large tiles, please check our website for details as to how to pack them on top of the insert trays.

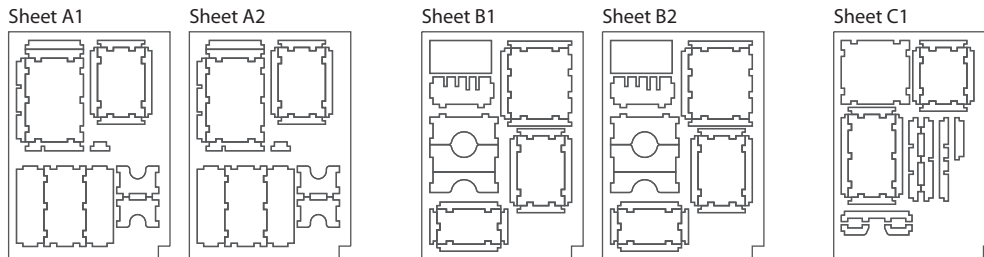
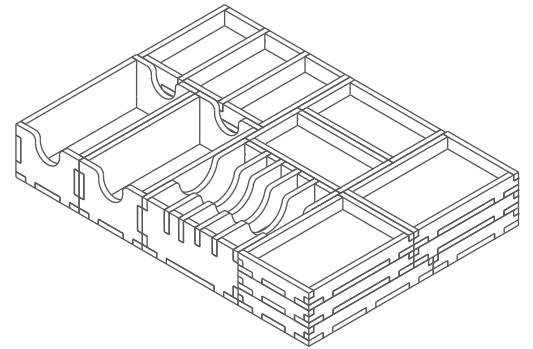

Tray 1a, 1b, 1c & 1d (the trays are identical)

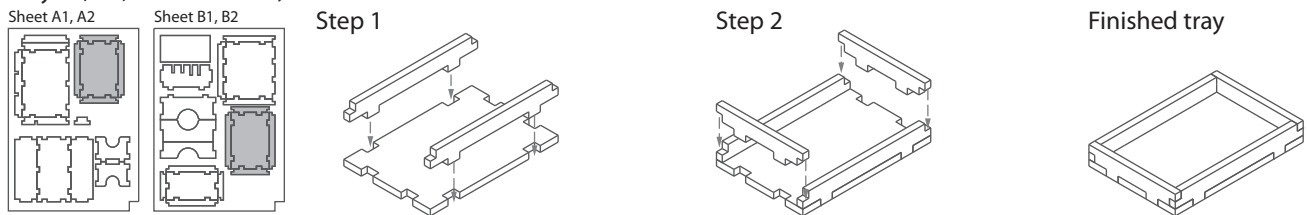

Tray 2
Sheet C1
To assemble repeat steps of Tray 1a-1d.

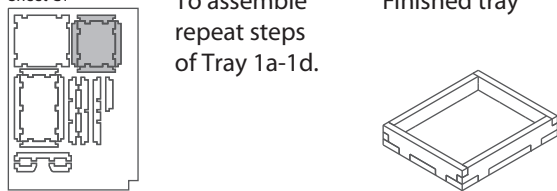

Tray 3a & 3b (the trays are identical)

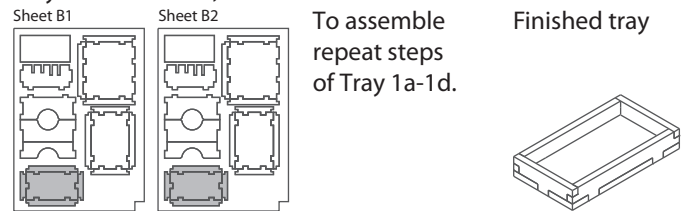

Tray 4
Sheet C1
To assemble repeat steps of Tray 1a-1d.

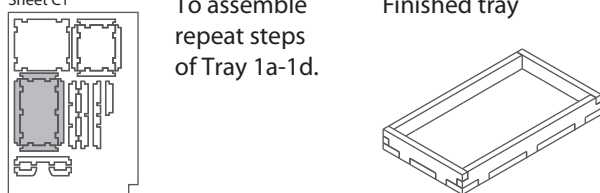

Tray 5a
Sheet B1
Sheet B2
To assemble repeat steps of Tray 1a-1d.

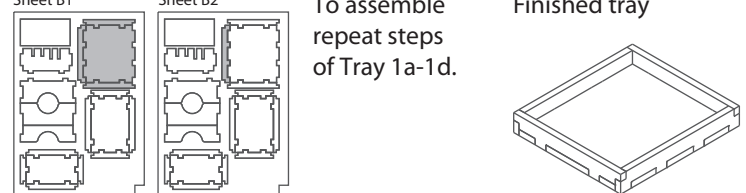

Tray 5b
Sheet B2
Sheet C1
Step 1

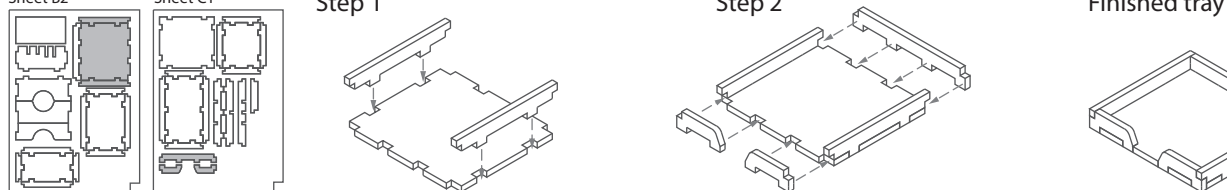

Tray 6
Sheet A1
Sheet A2
Step 1

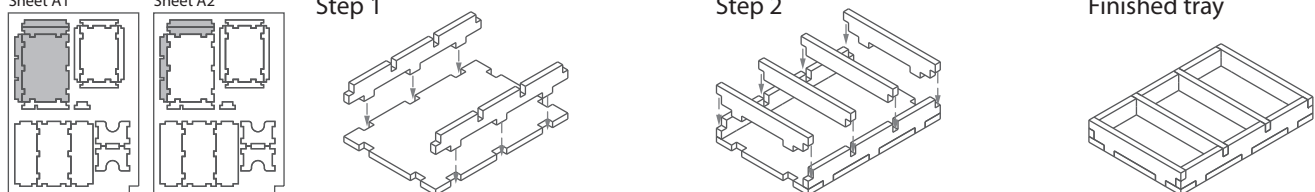

Tray 7a & 7b (the trays are identical)

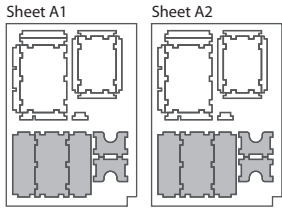

Step 1

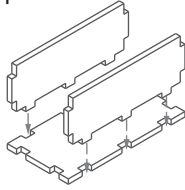

Step 2

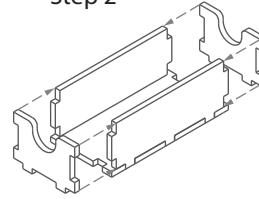

Finished tray

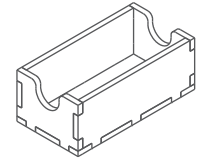

Tray 8

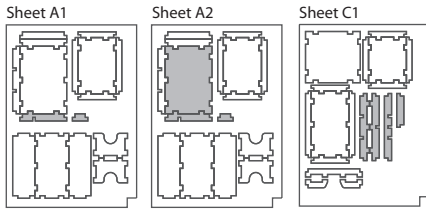

Step 1

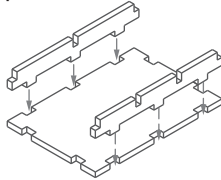

Step 2

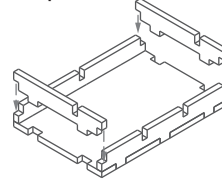

Step 3

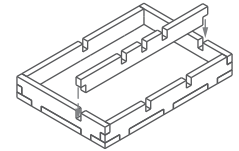

Step 4

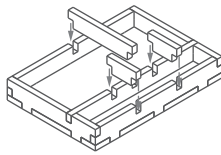

Finished tray

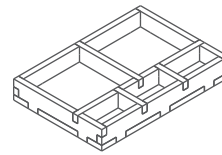

Tray 9

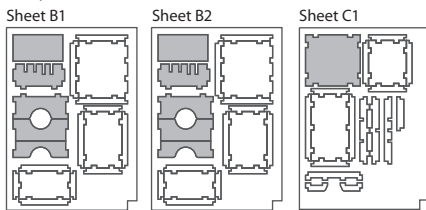

Step 1

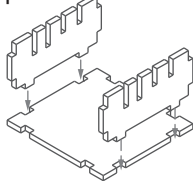

Step 2

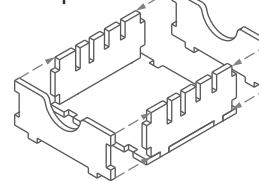

Step 3

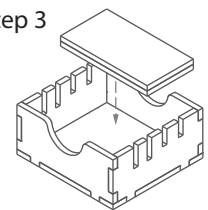

Step 4

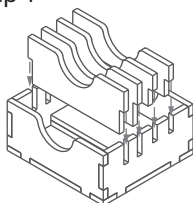

Finished tray

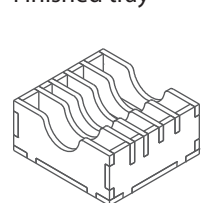

FS-ARLE

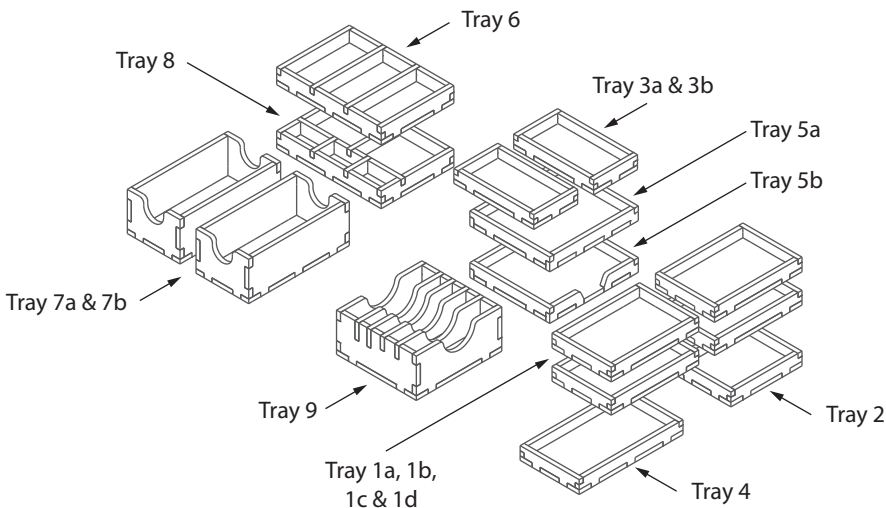

Please check www.foldedspace.net for photos of this insert in use.

Tray legend:

- Tray 1a, b, c - player pieces, including travel destinations and dike tiles
- Tray 1d - peat cubes
- Tray 2 - goods indicators, half-year counter, and starting player markers
- Tray 3a - wooden ditches
- Tray 3b - sheep meeples
- Tray 4 - cattle meeples
- Tray 5a - horse meeples
- Tray 5b - scoring pads
- Tray 6 - clay, wood, and resource tiles
- Tray 7a, b - forest, stall, stable, field, and building tiles, plus the three clothing x5 tiles
- Tray 8 - wool, leather, and linen clothing tiles
- Tray 9 - cart, carriage, handcart, peat boat, fishing cutter, and trading ship tiles