

FS-QUA insert
compatible with The Quacks of Quedlinburg®,
incl. The Herb Witches® expansion

Assembly Instructions

The package contains 4 sheets, two of them identical to the other two.

The part marked in sheet B2 is to be discarded.

After assembly the trays are put in three layers in the original game box.

Ordinary PVA glue is required when assembling each tray.

Please make sure you dry-assemble each tray correctly before gluing it together.

Please check www.foldedspace.net for general assembly tips.

FS-QUA

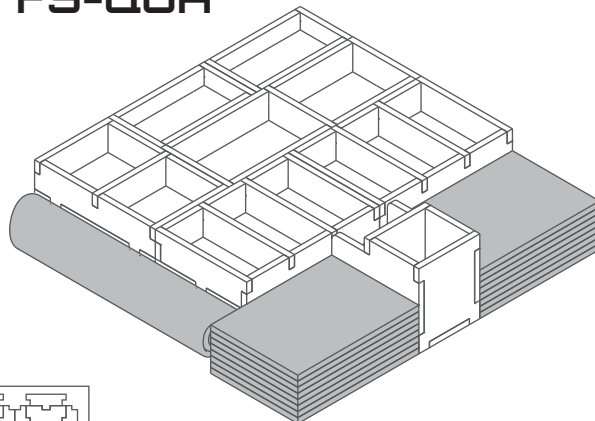

Sheet A1

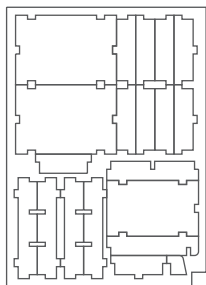

Sheet A2

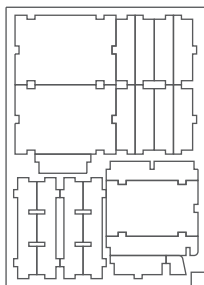

Sheet B1

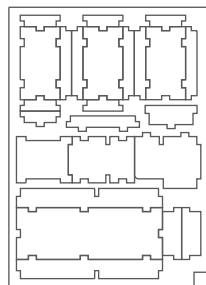

Sheet B2

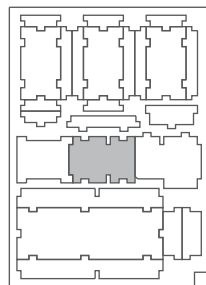

Tray 1a, 1b, 1c & 1d (the trays are identical)

Sheet A1

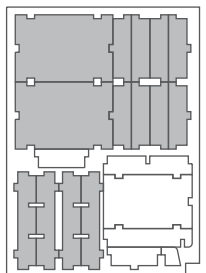

Sheet A2

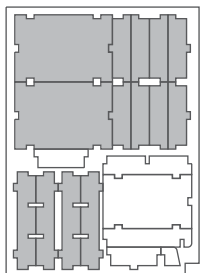

Step 1

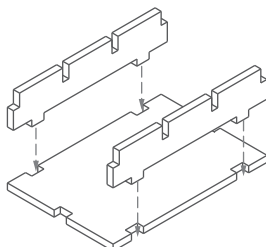

Step 2

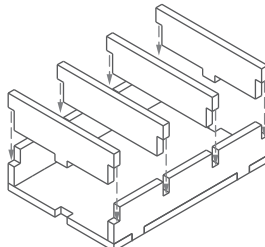

Finished tray

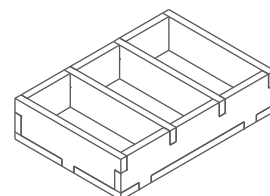

Tray 2a

Sheet A1

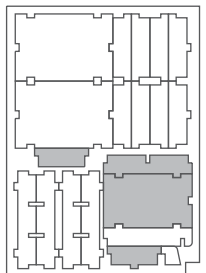

Sheet A2

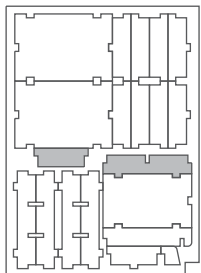

Step 1

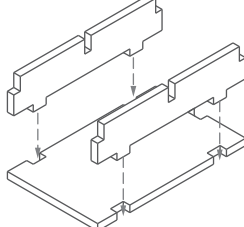

Step 2

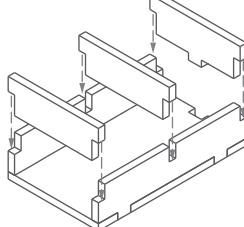

Finished tray

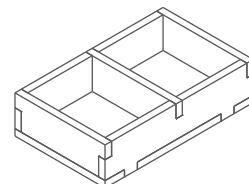

Tray 2b

Sheet A1

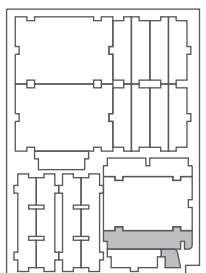

Sheet A2

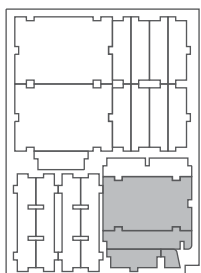

Step 1

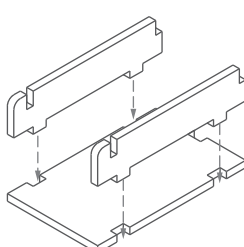

Step 2

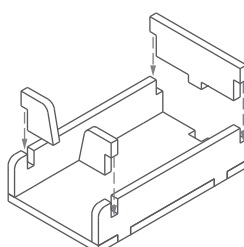

Finished tray

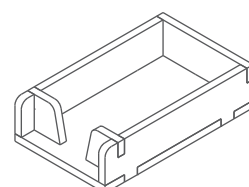

Tray 3a, 3b, 3c, 3d, 3e & 3f (the trays are identical)

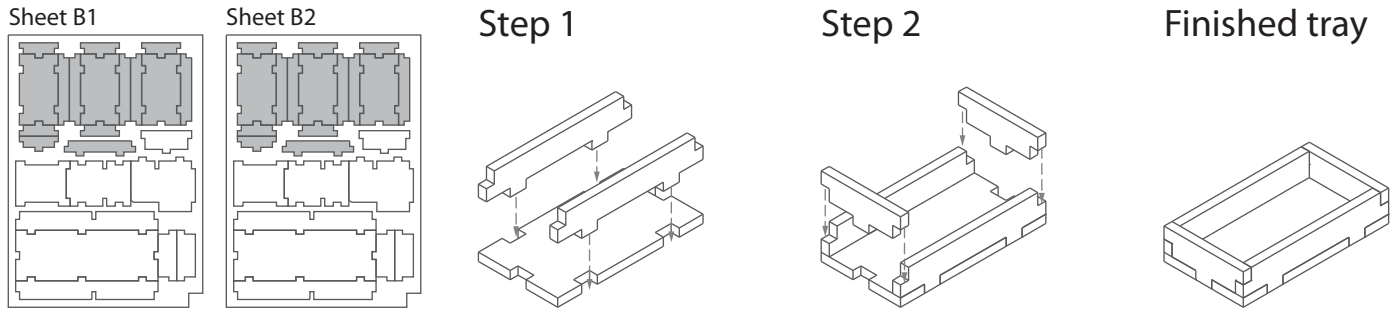

Tray 4a & 4b (the trays are identical)

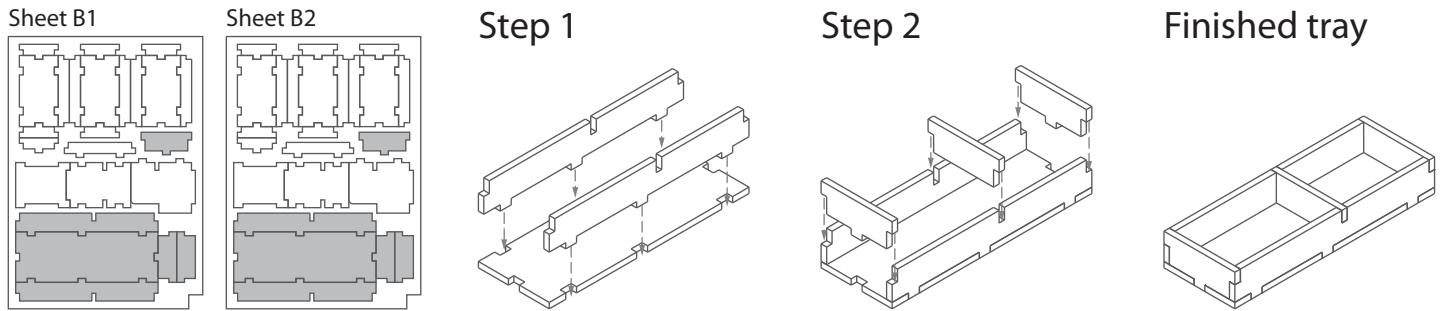

Tray 5

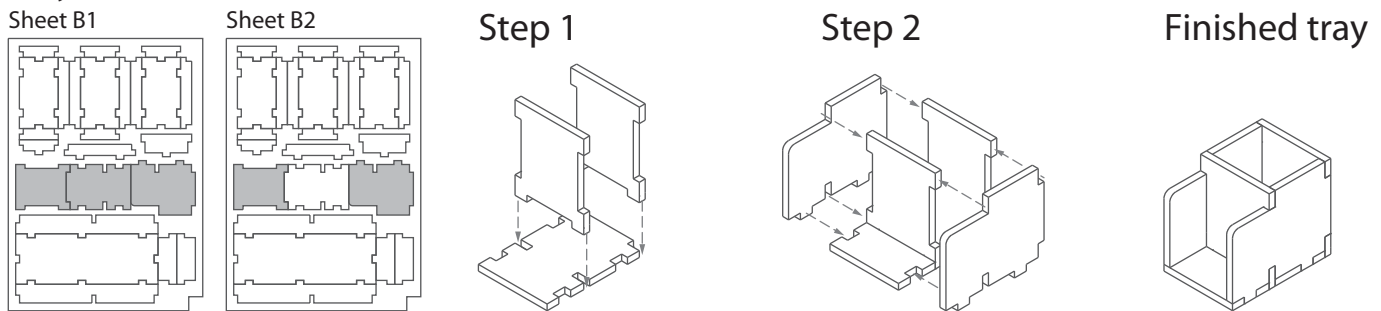

FS-QUA

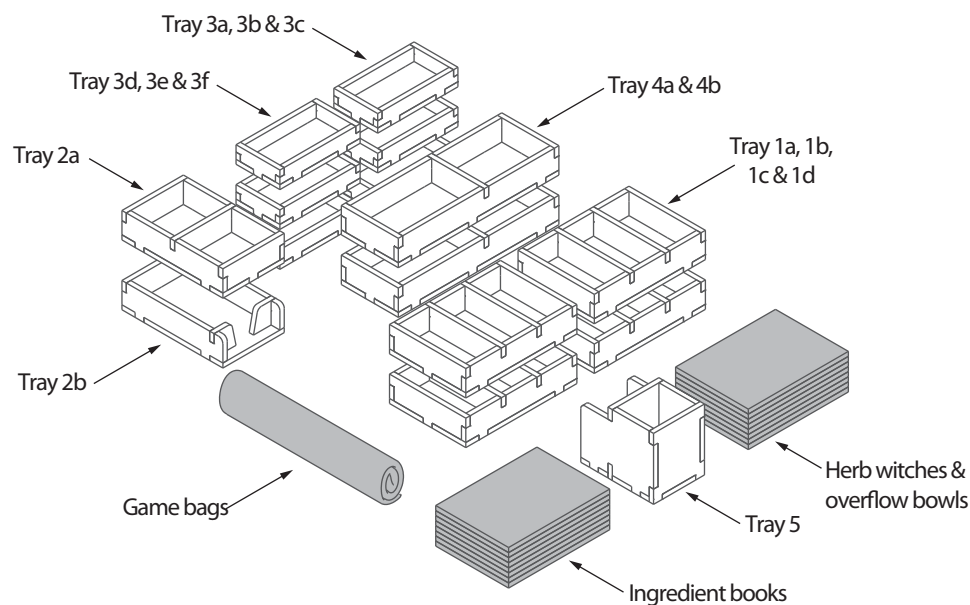

Please check www.foldedspace.net for photos of this insert in use.

Tray legend:

- Tray 1a, b, c, d - green, blue, red & yellow ingredient chips
- Tray 2a - rubies, die & locoweed chips
- Tray 2b - fortune teller cards
- Tray 3a, b, c, d, e - player pieces, incl. starting white ingredient chips
- Tray 3f - flame marker & replacement chips
- Tray 4a - orange ingredient chips
- Tray 4b - purple & black ingredient chips
- Tray 5 - filler tray