

FS-IMP insert

compatible with Imperial Settlers®, or 51st State®

incl. Aztecs®, Atlanteans®, Amazons®, Why Can't We Be Friends®, 3 is a Magic Number® and We Didn't Start the Fire® expansions for Imperial Settlers®.



Assembly Instructions

The package contains 4 sheets, two of them are identical to the other two.

After assembly the trays are put in two layers in the original game box.

Ordinary PVA glue is required when assembling each tray.

Please make sure you dry-assemble each tray correctly before gluing it together.

Please check www.foldedspace.net for general assembly tips.

FS-IMP

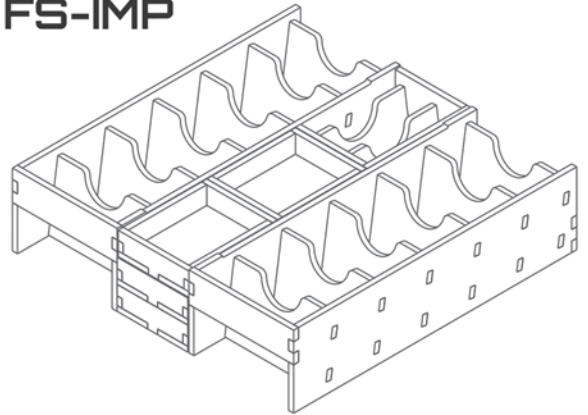

Sheet A1

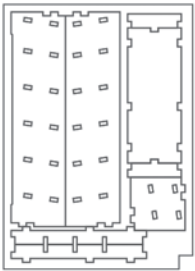

Sheet A2

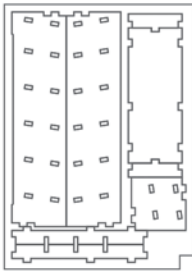

Sheet B1

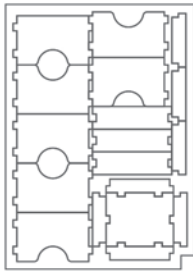

Sheet B2

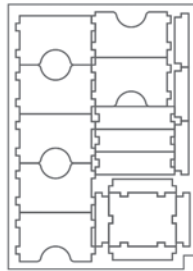

Tray 1a

Sheet A1

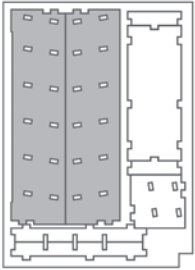

Sheet B1

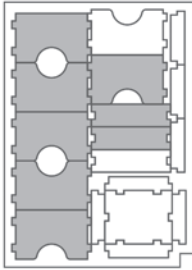

Step 1

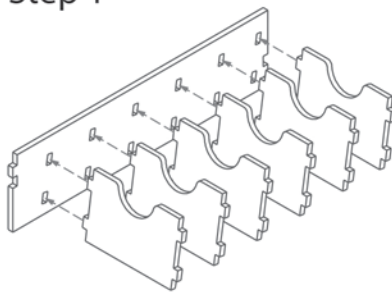

Step 2

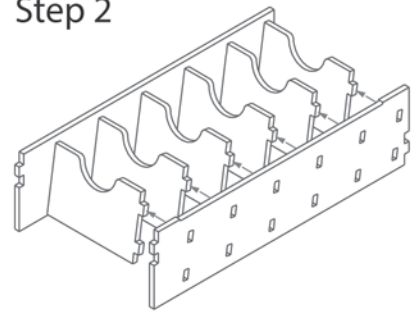

Step 3

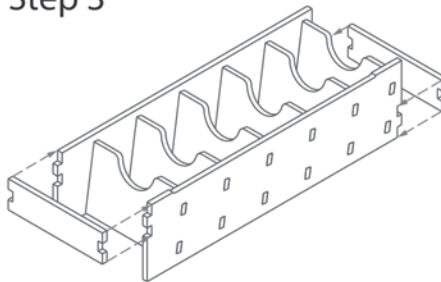

Finished tray

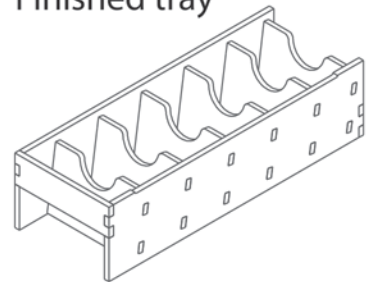

Tray 1b (the tray is mirrored version of Tray 1a)

Sheet A2

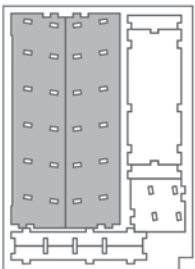

Sheet B2

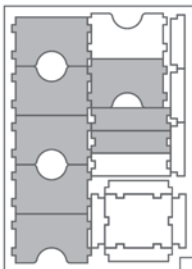

To assemble follow steps of Tray 1a.

NOTE:
Swap side walls to assemble *mirrored* version of Tray 1a.

Finished tray

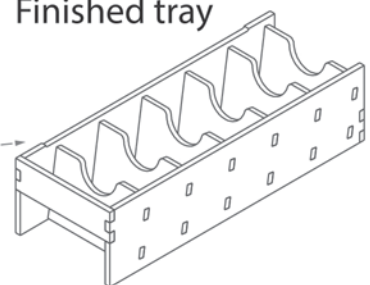

FS-IMP insert compatible with Imperial Settlers®, or 51st State®

incl. Aztecs®, Atlanteans®, Amazons®, Why Can't We Be Friends®, 3 is a Magic Number® and We Didn't Start the Fire® expansions for Imperial Settlers®.



Tray 2a & 2b (the trays are identical)

Sheet B1

Sheet B2

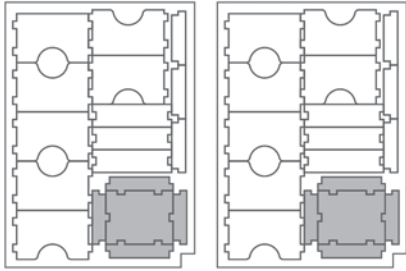

Step 1

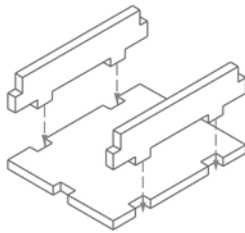

Step 2

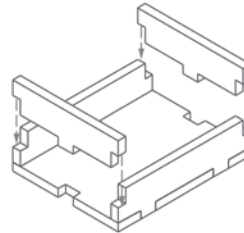

Finished tray

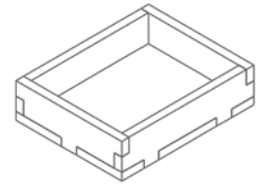

Tray 3a & 3b (the trays are identical)

Sheet A1, A2

Sheet B1, B2

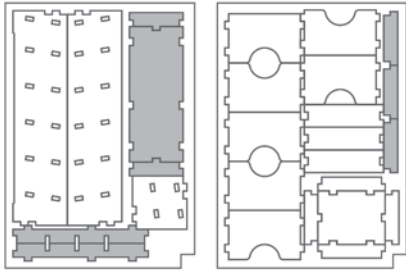

Step 1

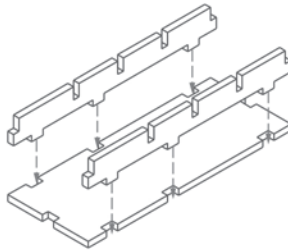

Step 2

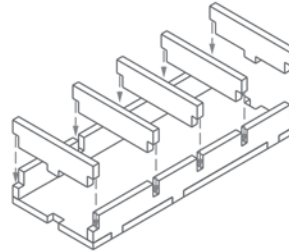

Finished tray

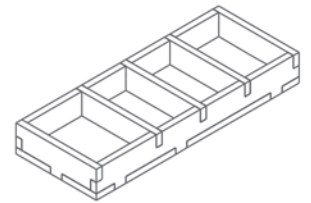

Tray 4

Sheet A1, A2

Sheet B1, B2

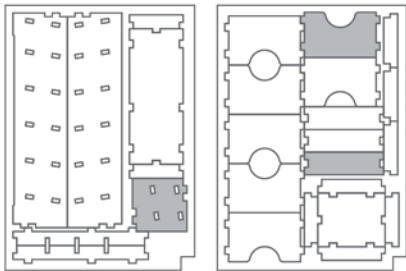

Step 1

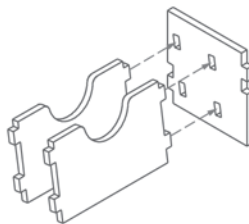

Step 2

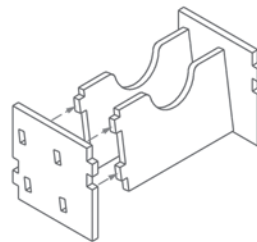

Step 3

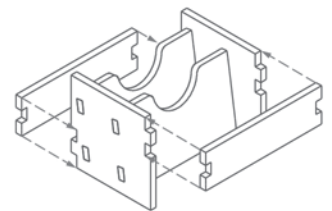

Finished tray

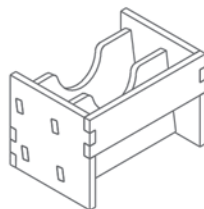

FS-IMP

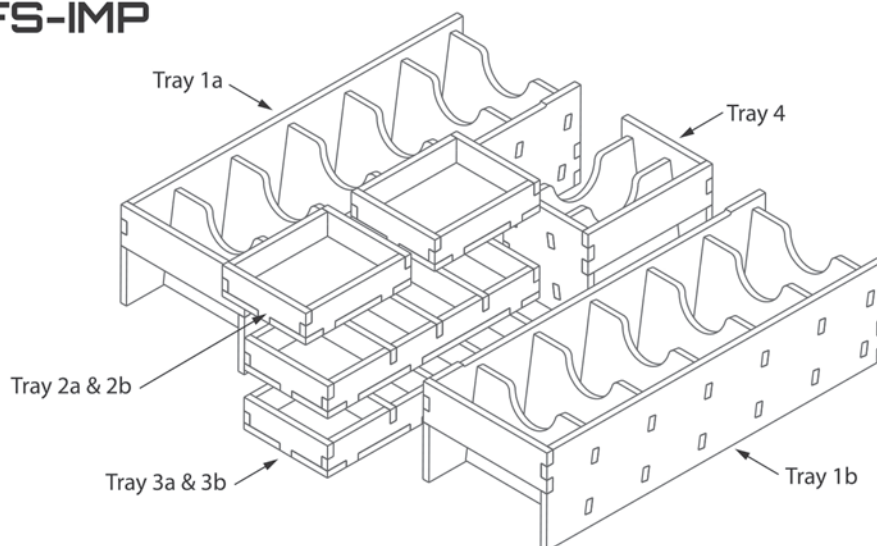

Please check www.foldedspace.net for photos of this insert in use.

Tray legend

for Imperial Settlers:
 Tray 1a, b - large cards
 Tray 2a - aztec tokens
 Tray 2b - atlantean tokens
 Tray 3a - goods & workers
 Tray 3b - raze, defense, gold & other tokens
 Tray 4 - large cards

for 51st State:
 Tray 1a, b - large cards
 Tray 2a - worker pieces
 Tray 2b - fuel pieces & other tokens
 Tray 3a - goods & contact tokens
 Tray 3b - goods & other tokens
 Tray 4 - large cards

Tip: Keep the instructions in the bottom of your board game box as a reminder of how the insert fits together.