

FS-LCG2 insert

compatible with Living Card Games®,

such as Arkham Horror®, Legends of the Five Rings®, A Game of Thrones® 2nd Ed., Android: Netrunner® Revised Core Set, Blood Bowl Team Manager® and many others



This insert is designed for the new smaller standard of Living Card Games® with external game box dimensions: 25.4 x 25.4 x 5.1 cm.

The package contains 4 identical sheets.

After assembly, tray 5 should be placed in the game box and not removed. The other trays are meant to be removed and used in game play.

Ordinary PVA glue is required when assembling each tray, for extra strength.

Please make sure you dry-assemble each tray correctly before gluing it together.

Please check www.foldedspace.net for general assembly tips.

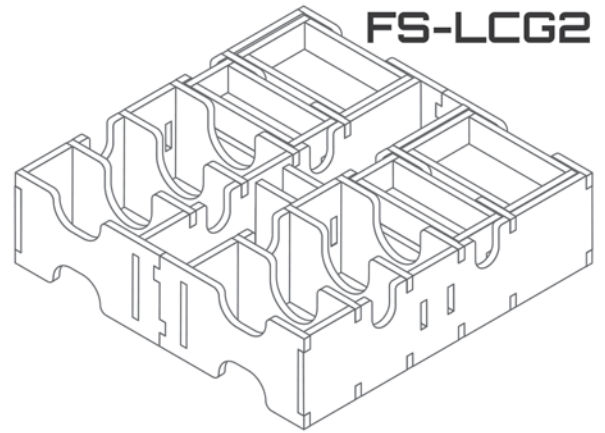

Token tray 1a & 1b (the trays are identical)

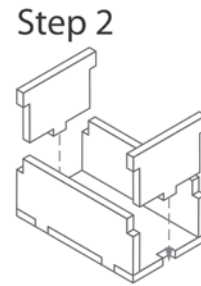
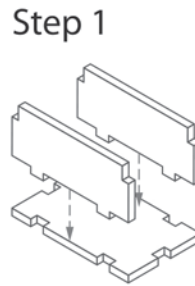
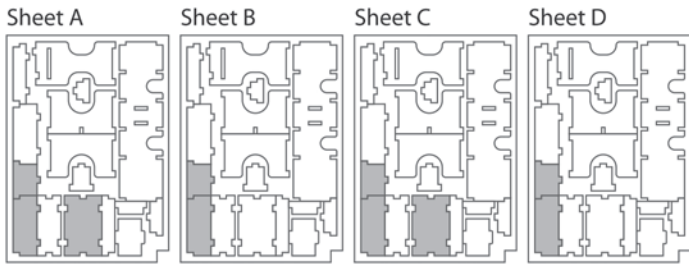

Token tray 2a & 2b (the trays are identical)

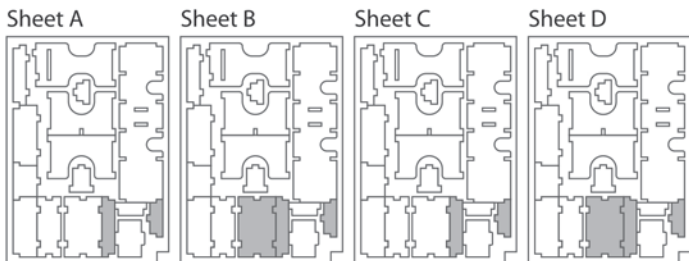

To assemble repeat steps for Tray 1.



Token tray 3a & 3b (the trays are identical)

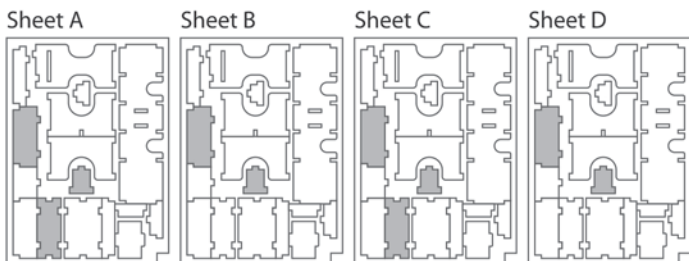

To assemble repeat steps for Tray 1.



Token tray 4a & 4b (the trays are identical)

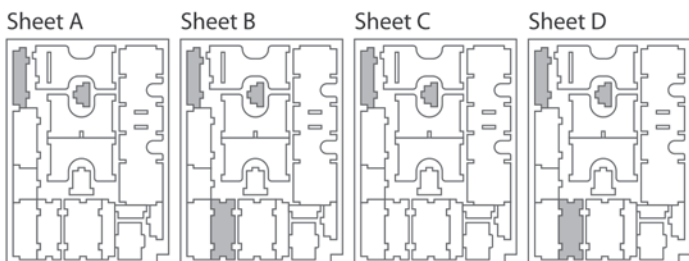

To assemble repeat steps for Tray 1.



Tray 5, section 5a

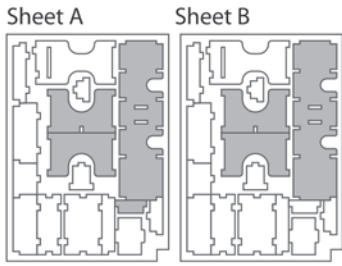

Step 1

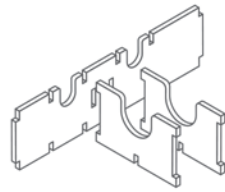

Step 2 (optional, if game has small cards)

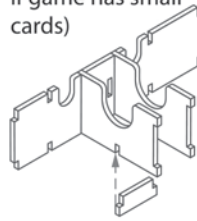

Step 3

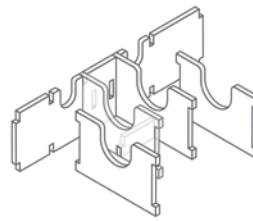

Step 4

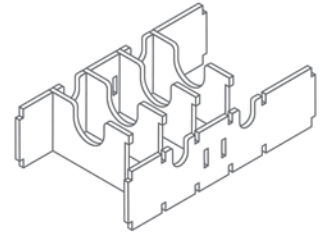

Note: No glue is needed in steps 1, 3 and 4.

Tray 5, section 5b

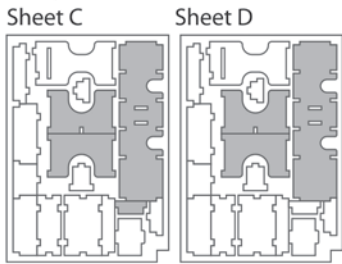

To assemble
repeat steps
for section 5a.

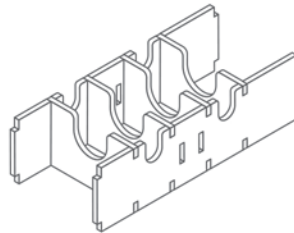

Tray 5, final assembly

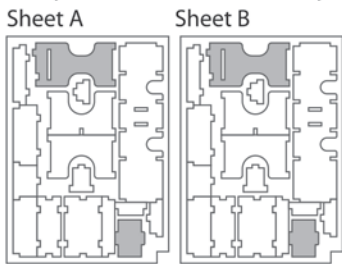

Step 1

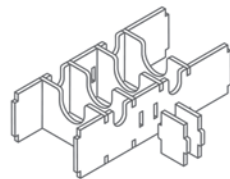

Step 2

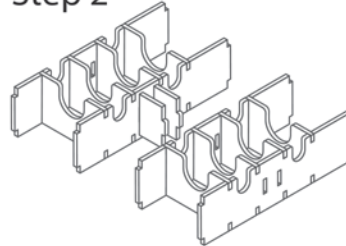

Step 3

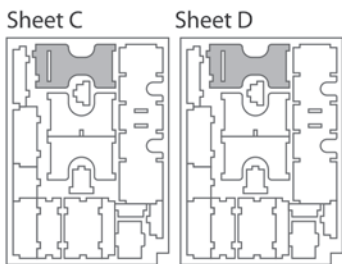
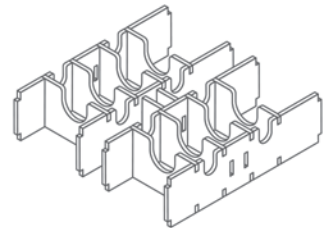

Step 4

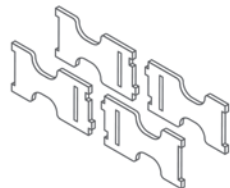

Step 5

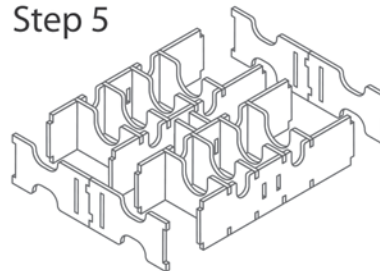

Finished tray

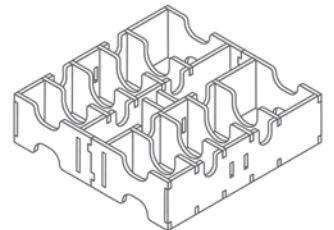

Optional steps:

To store tokens, put Trays 1 & 2 in the largest card slot of Tray 5

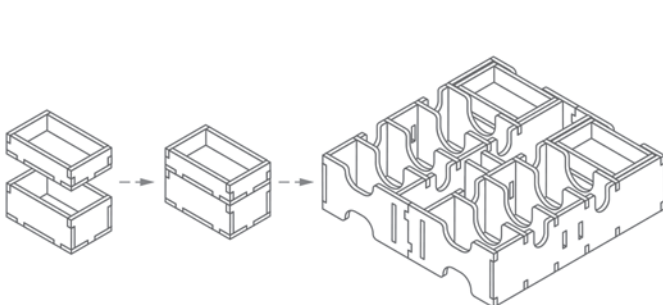

To store more tokens, put all token trays in Tray 5

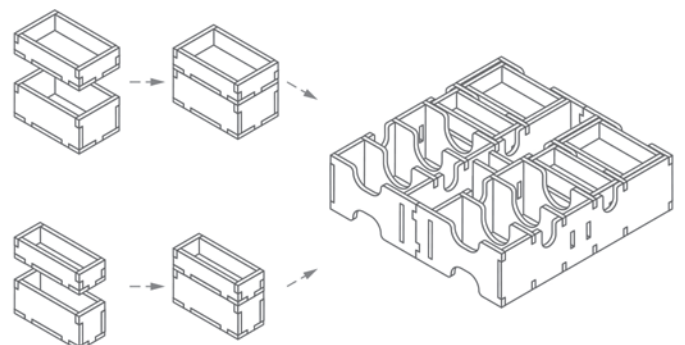

Note: Token trays can be used in any combination depending on the tokens in the game that you are using the insert for.

Please check www.foldedspace.net for photos of this insert in use in various games.